







20 006 706

- with CASCADE structure
- hole diameter 32 mm
- rosette 60 x 47 mm
- with hot marking



|   |                               |               |
|---|-------------------------------|---------------|
|  | Brushed Champagne (22kt Gold) | 20 006 706-46 |
|  | Chrome                        | 20 006 706-00 |
|  | Brushed Platinum              | 20 006 706-06 |
|  | Dark Chrome                   | 20 006 706-19 |
|  | Champagne (22kt Gold)         | 20 006 706-47 |
|  | Brushed Dark Platinum         | 20 006 706-99 |

20 006 706

mm [inches]

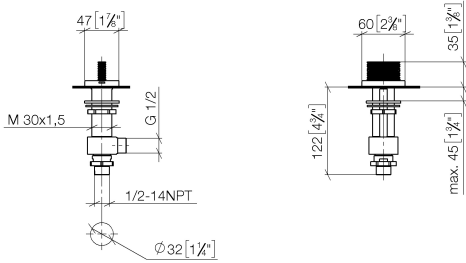

Flow rate chart



Certificates

IAPMO\_N-4976. LGA\_28687. IAPMO\_6397. WRAS\_240202020.

20 006 706

Parts for other finishes can be found here: [Chrome](#)

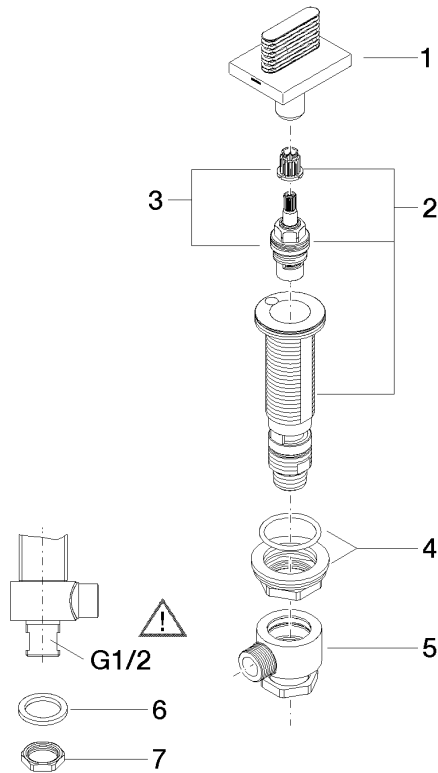

### Spare parts list

| No.  | Item Number        | Name               | Quantity used | Delivery time |
|--|--------------------|--------------------|---------------|---------------|
| 1  | 90 20 70 053 07-46 | handle ( hot )     | 1             | 30            |
| 2  | 04 17 11 058 52 90 | side panel         | 1             | 2             |
| 3  | 90 90 03 152 00 90 | top                | 1             | 2             |
| 4  | 04 23 10 032 78 90 | fixing set         | 1             | 2             |
| 5  | 04 17 11 023 10 90 | distributor        | 1             | 2             |
| 6  | 90 23 30 040 00-46 | threaded connector | 1             | -             |
| Spare part can no longer be ordered, please order the replacement item |                    |                    |               |               |
| 7  | 09 30 11 059 90    | disc               | 1             | 2             |
| 8  | 09 23 10 012 90    | nut                | 1             | 2             |